

1. Room ID 4"x6"
Mir1700

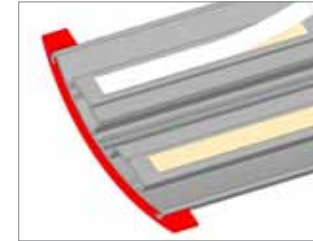
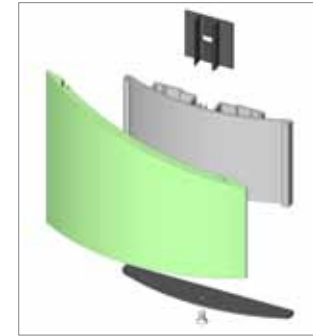

d
ACCENT BAR
(available page no.*)
finish/color options:
1. Standard Mirtec anodized colors
2. Can be painted or powder coated

Room ID (A) 4"x6"

NOTES:

a

EXTRUSION finish/color options:
are made from high quality aluminum 6063 with an anodized or oven cured coating
1. Clear anodized aluminum

b

INSERT OPTIONS:
1. Graphic sign fronts:
engraved, laminated, silk screened, Imprinted with braille or photo metal finished
2. Applied vinyl on aluminum insert
3. .040 aluminum backed photopolymer w/ raised symbols/copy and ADA compliant braille. Tip symbols/copy to contrast background color
4. Acrylic cover w/ paper insert
5. Digital printing onto anodized aluminum by Primodize® or direct on clear cover

c

END CAPS finish/color options:
1. Clear anodized aluminum
2. Can be painted or powder coated
3. Gray or black ABS plastic

Divider

1. Natural or anodized alum strips

— STANDARD OPTIONS: —

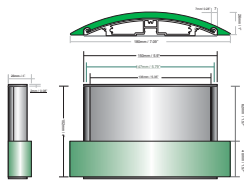

2. Room ID 4"x6"
Mir1701

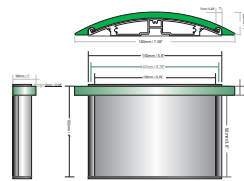

3. Room ID 4"x6"
Mir1702

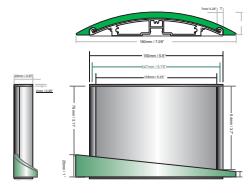

4. Room ID 4"x6"
Mir1703

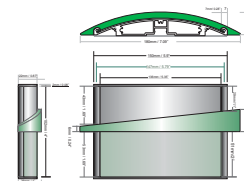

5. Room ID 4"x6"
Mir1704

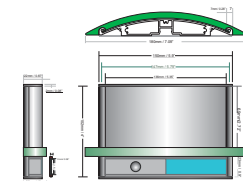

6. In Use Slider 4"x6"
Mir1705

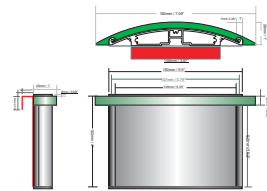

7. Cubicle 4"x6"
Mir1706