

1. Room ID 6"x6"
Mir2728

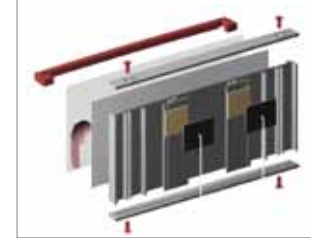
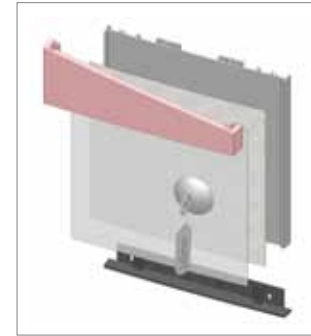

d
ACCENT BAR
(available page no.*)
finish/color options:
1. Standard Mirtec anodized colors
2. Can be painted or powder coated

Venus Accentia Sign Family

Room ID (AA) 6"x6"

NOTES:

- a**
EXTRUSION finish/color options:
are made from high quality aluminum 6063 with an anodized or oven cured coating
1. Clear anodized aluminum
- b**
INSERT OPTIONS:
1. Graphic sign fronts:
engraved, laminated, silk screened, Imprinted with braille or photo metal finished
2. Applied vinyl on aluminum insert
3. 1. .040 aluminum backed photopolymer w/ raised symbols/copy and ADA compliant braille. Tip symbols/copy to contrast background. braille to remain background color
4. Acrylic cover w/ paper insert
5. Digital printing onto anodized aluminum by Primodize® or direct on clear cover

- c**
END CAPS finish/color options:
1. Clear anodized aluminum
2. Can be painted or powder coated
3. Gray or black ABS plastic

- Divider
1. Natural or anodized alum strips

— STANDARD OPTIONS: —

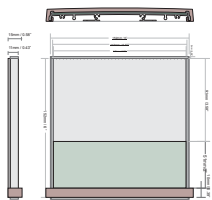

2. Room ID 6"x6"
Mir2729

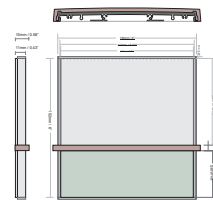

3. Room ID 6"x6"
Mir2730

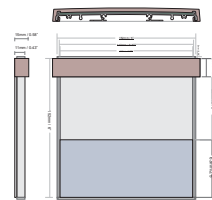

4. Room ID 6"x6"
Mir2731

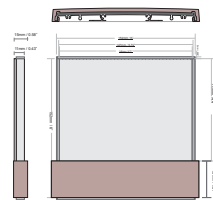

5. Room ID 6"x6"
Mir2732

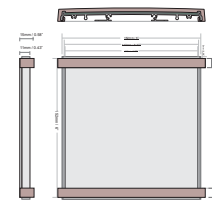

6. Room ID 6"x6"
Mir2733

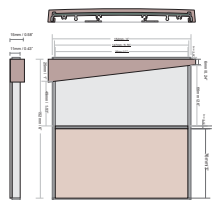

7. Room ID 6"x6"
Mir2734

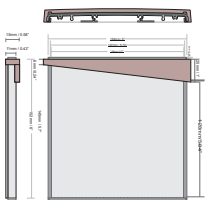

8. Room ID 6"x6"
Mir2735

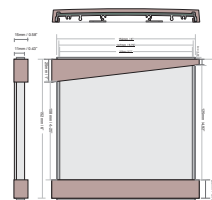

9. Room ID 6"x6"
Mir2736

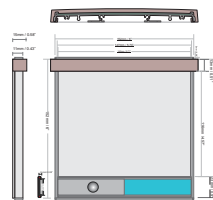

10. In Use Slider 6"x6"
Mir2737

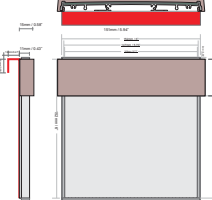

11. Cubicle 6"x6"
Mir2738